

MORCO |   
RIB® Canopy System

HARRODS LTD

Harrods

THE HARRODS SALE

UP TO 28% OFF LADIES FOOTWEAR  
HARRODS CARD EXCLUSIVE

SAVE 10% THIS WEEKEND  
ON ALL THE HATS, GLOVES & BOOTS

28.9%

harrods.com

08

## RIB® Canopy System

---

### Index

- 6 History & Present Day**
- 8 Design & Craftsmanship**
- 10 Application & Construction**
- 12 Finishing & Customisation**

### RIB® Canopy System

- 15 RIB® Dutch Canopy
- 17 RIB® Wedge Canopy
- 19 RIB® Umbrella Canopy
- 21 RIB® Eyelid Canopy
- 23 RIB® Bespoke Canopy
- 25 RIB® Bullnose Entrance
- 27 RIB® Apex Entrance
- 29 RIB® Manhattan Entrance

### Specification Guide

- 32 RIB Canopy Overview
- 33 RIB Entrance Overview
- 34 Frame, Centre Leg, Pole and Planter

### Fixing Specification

- 36 Frame
- 37 Centre Leg
- 38 Pole and Planter

### Options

- 40 Valance
- 41 Branding
- 42 Rear Panel

### Finishes

- 44 Fabric Plain
- 46 Fabric Striped
- 47 Metalwork
- 48 Trim

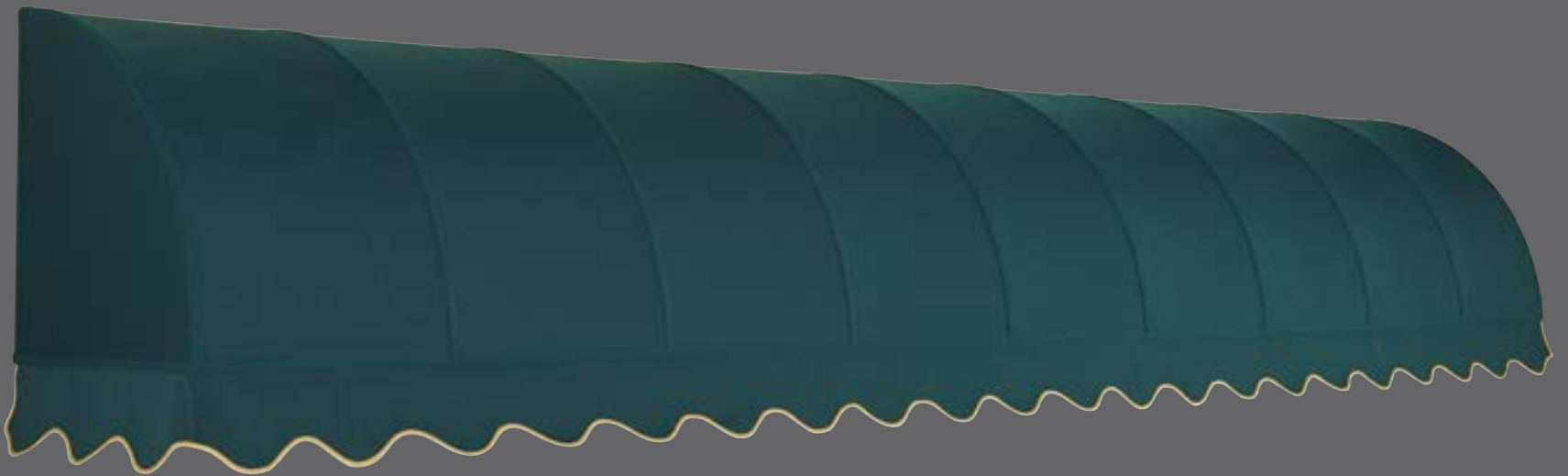

Recognised as a design classic, the RIB® Canopy System is expertly hand-crafted in our Thameside workshop, this traditional awning is strong, practical and versatile and remains a specified option with design teams and architects. It is the recommended choice for listed and historic buildings, but is an equally sought-after solution for projects in a more contemporary setting.

SEXY FISH

SEXY FISH



## History

Morco was founded in London in 1956 by Mr G H Morrison, as a specialist manufacturer of canopies, covers, sails and tarpaulins for London's busy waterways. His popularity with employees and customers saw his business grow steadily. 1967 saw Morco move to the current Riverside location on the Greenwich Peninsula. In 1978, his son George took over. Keen to utilise his design background, he began to construct specialist awnings on a much larger scale. With his fanatical attention to detail, Morco soon gained a reputation across the UK for outstanding quality awnings.



## Present Day

For over 50 years, Morco have established themselves as the nation's leading design and manufacturer of custom-made awnings and canopies. It remains a family run business that prides itself on its heritage. There remains a dedicated and skillful team of craftsman and designers who all play a vital role in Morco's success story. The majority of products are still hand-built in our London workshop and a small amount are produced in Germany. Morco are keen to lead and focus heavily on pioneering new techniques or materials to improve our end products and deliver more options to our customers.



# ronnie scott's

ronnie's bar

ronnie scott's

**ronnie's BAR**  
OPEN MONDAY-SUNDAY 6PM TILL LATE  
LIVE EVENTS MOST NIGHTS  
www.rommiesbar.co.uk  
BAR FOOD / AWARD WINNING COCKTAILS

**JANUARY** ronnie scott's

<b>THE MAY FLAMES</b>	<b>DAVE NAVARRO</b>
<b>THE BROTHERS</b>	<b>CARLEEN ANDERSON</b>
<b>BOOKER T JONES</b>	<b>BEYONCÉ</b>
<b>THE BROTHERS</b>	<b>BLANK &amp; INDEX</b>
<b>THE BROTHERS</b>	<b>WINKA DUFFY COOKE</b>

020 7439 0747  
www.rommiescotts.co.uk

ronnie scott's

## Design

We have a talented and experienced design team skilled at working with and collaborating with architects, designers and contractors to achieve the perfect awning solution for projects ranging from the simple to the most complex. Our ability in producing extensive awning designs including digital visuals, 3D-models, DWG's and technical drawings, as well as manufacturing samples and prototypes, also mean we are able to work directly for clients at the earliest stage of a project. As part of our unparalleled awning design service we are also able to offer clients the opportunity to utilise our cutting-edge RAGS branding and patterning system which has revolutionised the traditional parameters of fabric design.



## Craftsmanship

Our manufacturing team combines a tradition of experienced craftsmen with uniquely skilled technicians. Proud of our reputation as market leaders, their dedication to projects from the simplest to the most challenging is unmatched. Every awning and canopy is individually handcrafted with the utmost care given to achieve perfection in all. Our clients are able to visit our workshop and as see all aspects of their awning created, from the fabrication and powdercoating of the metalwork to the crafting of the timber and creation of the fabric covers.







## Application

Famously used on some of Europe's best known stores and buildings, the RIB canopy has always been a popular choice. Originating in France, it's enduring popularity has predominantly been due to the broad pallet of shapes and styles made possible with it's clever construction. Able to adapt to most types of shopfronts and fascias, the bespoke curvature of the frame can work with minimalist or grand façades to ensure nothing of the buildings architecture is lost, only enhanced. Even after a century of use we are still creating RIB canopies in a variety of classic, original and striking designs.



## Construction

Although we pride ourselves on the coupling of traditional craftsmanship with cutting-edge technology, nowhere is this as evident as with the RIB canopy. Although the traditional method of creating a frame and fitting it with a tensioned fabric covering remains the same, we have developed a unique extruded framework with increased strength making it possible to construct greater dimensions, tensioning and design configurations. Although our Rib is the strongest in the country it also has smallest section at 25mm square. We are the only company to weld joins instead of riveting.





## Finishing

With the wide range of fabric colours and metal finishes available the RIB® System offers endless possibilities to suit any setting. Metalwork finishes can be anodised or powdercoated to any RAL colour and all fabric colours are solution dyed. The fabric protected to maintain resistance throughout the life span of the awning and withstand the most demanding weather conditions. Also rather than the unattractive PVC tack-on trim used by all other companies, we are the only company to offer perfectly coordinated trim made from the same fabric as the cover.



## Customisation

All elements of the RIB® Canopy System are customisable, from its shape and size to the colours and branding. Whether from our classic range of RIB styles or something more modern and bespoke, every canopy is uniquely made with our designers able to help create the canopy perfect for you.

















BISTRO · RESTAURANT

BAR · CAFÉ

LES  
DEUX SALONS

BAR  
CAFÉ

LES  
DEUX SALONS



DICKIE'S BAR  
CORRIGAN'S MAYFAIR

CORRIGAN'S







ALL WEEK  
ON SUNDAY



A TOTALLY NEW CONCEPT IN TAXI SERVICES



RED ROUTE  
No stopping  
of any kind



SEXY FISH  
セクシーフィッシュ

SEXY FISH  
セクシーフィッシュ

BRUTON  
LANE W1  
CITY OF WESTMINSTER







THE REDBAR





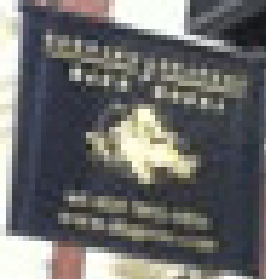





CLUB QUARTERS

CLUB QUARTERS

CLUB QUARTERS



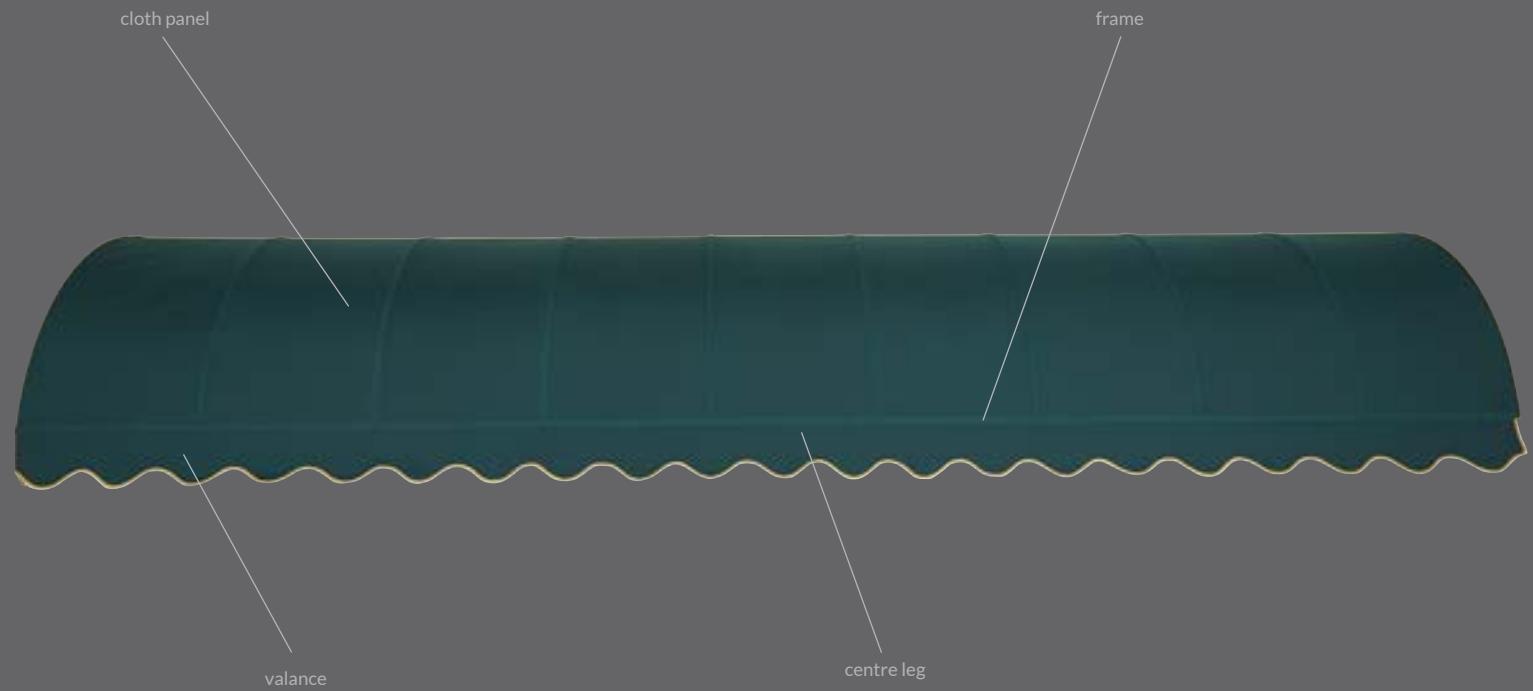





### Centre Leg

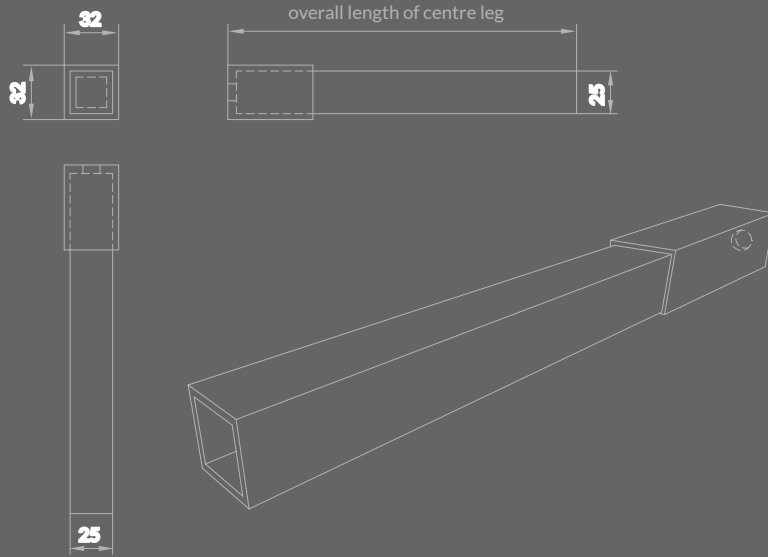

### Pole

#### concealed tube base

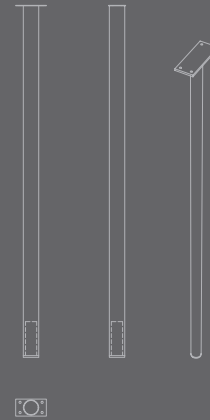

#### surface mounted plate

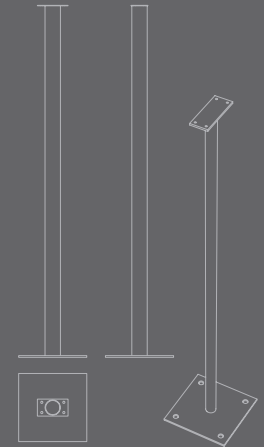

### Frame & Trim

#### concealed pipe trim

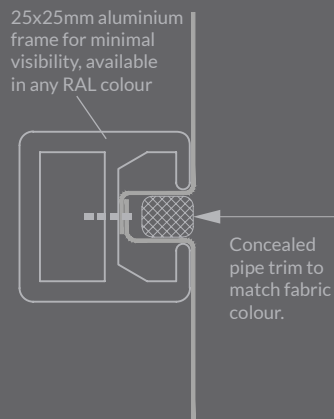

#### concealed tape trim

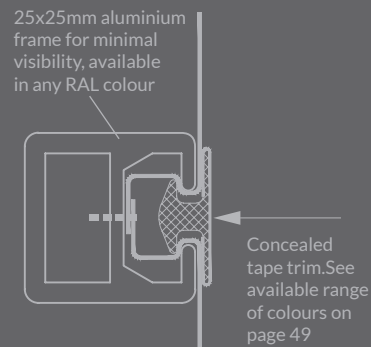

Fabric connected directly to aluminium section for strengthened tensioning of fabric.

### Planter

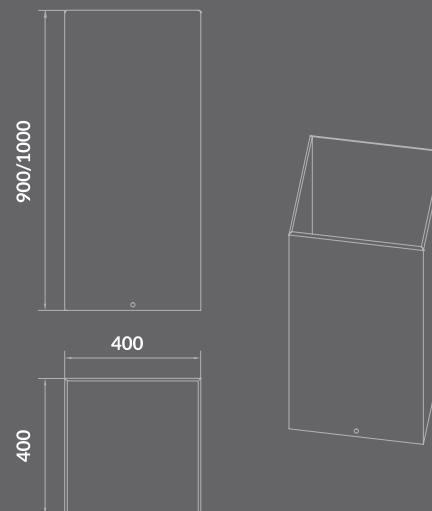



Fixing Specifications

RIB® Canopy System | Fixing Specifications | Frame

Timber

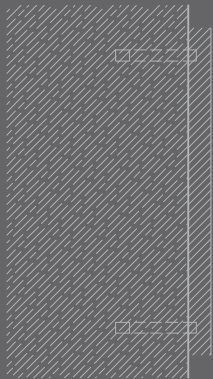

**Hardwood**  
**Fixing:** Coach screw  
**Size:** M8 x 65mm  
**Depth:** 50mm (min)

**Softwood**  
**Fixing:** Coach screw  
**Size:** M8x 80mm  
**Depth:** 75mm (min)

Steel



**Fixing:** Hex bolt  
**Size:** M8 x 20mm  
**Depth:** 8mm (minimum)

**Fixing position:**  
 Face fixed. Every 200mm  
 along the length of the  
 rear frame.

**Please note:** the information  
 on this page is for guidance  
 only. All projects to be  
 evaluated after site visit.

Concrete/Brickwork

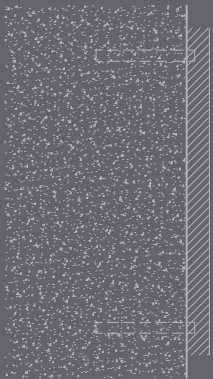

**Fixing:** Anchor bolt  
**Size:** M8 x 100mm  
**Depth:** 100mm (min)

Fascia Cladding

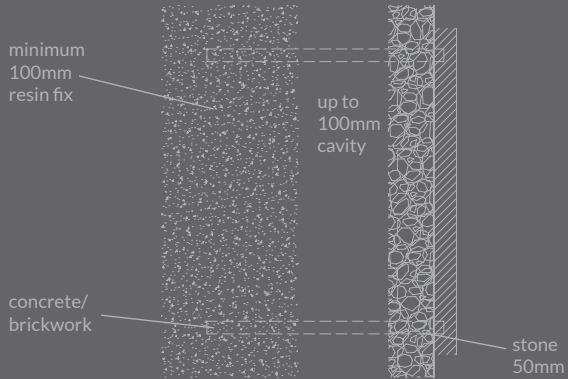

**Fixing:** Resin bolt / studding M8  
**Size:** M8 (studding length subject to application)  
**Depth:** 250mm (min)

Timber

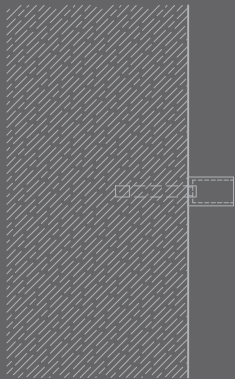

**Hardwood**  
**Fixing:** Coach screw  
**Size:** M12 x 65mm  
**Depth:** 50mm (min)

**Softwood**  
**Fixing:** Coach screw  
**Size:** M12 x 80mm  
**Depth:** 75mm (min)

Steel



**Fixing:** Hex bolt  
**Size:** M12 x 20mm  
**Depth:** 8mm (minimum)

**Fixing position:**  
 Face fixed. One centre leg required every approximately 3m when the width is longer than 4m.

**Please note:** the information on this page is for guidance only. All projects to be evaluated after site visit.

Concrete/Brickwork

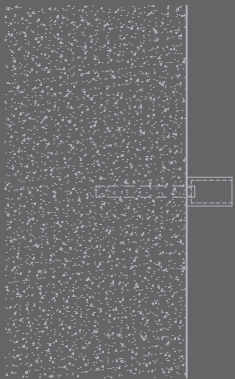

**Fixing:** Anchor bolt  
**Size:** M12 x 100mm  
**Depth:** 100mm (min)

Fascia Cladding

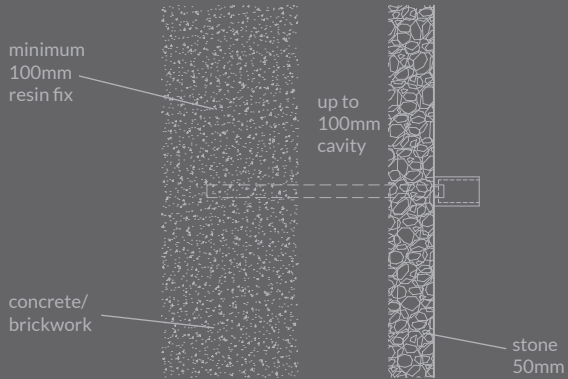

**Fixing:** Resin bolt / studding M12  
**Size:** M12 (studding length subject to application)  
**Depth:** 250mm (min)



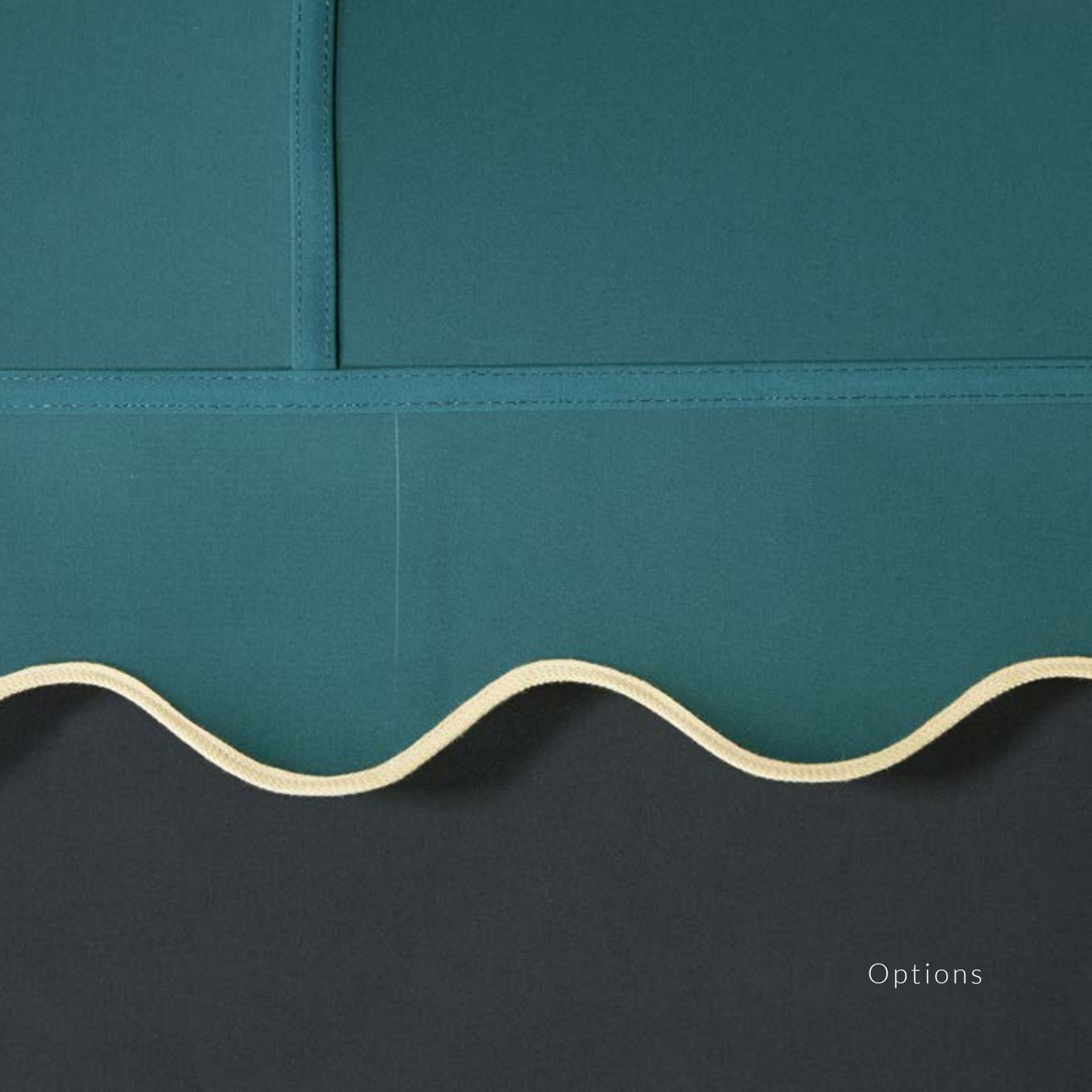

Options











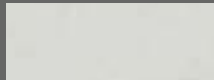





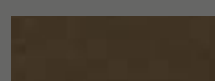

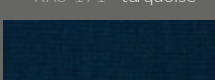
						
RKS-099 white	RKS-317 haya	RKS-122 seashell	RKS-117 raw	RKS-415 marble	RKS-217 ivory	RKS-220 argent
						
RKS-148 desert	RKS-115 cream	RKS-121 wheat	RKS-779 beige tweed	RKS-180 sand	RKS-145 tenerife	RKS-222 oak buff
						
RKS-133 cinnamon	RKS-126 linen	RKS-107 champagne	RKS-108 vanilla	RKS-113 cava	RKS-119 duna	RKS-100 beige
						
RKS-178 toast	RKS-139 heather beige	RKS-143 hemp beige	RKS-775 linen tweed	RKS-188 lemon	RKS-237 pineapple	RKS-239 yellow tweed
						
RKS-554 yellow	RKS-240 honey	RKS-149 corn	RKS-111 camel	RKS-158 ochre	RKS-101 mandarin	RKS-567 orange
						
RKS-185 pumpkin	RKS-106 Flamingo	RKS-241 Pheonix	RKS-105 salmon	RKS-176 red	RKS-182 vermillion	RKS-177 burgundy
						
RKS-104 chestnut	RKS-195 cacao	RKS-243 tapenade	RKS-244 dun	RKS-156 brown	RKS-181 coffee	RKS-165 mauve
						
RKS-110 lily	RKS-171 turquoise	RKS-193 light blue	RKS-229 sapphire	RKS-169 steel blue	RKS-172 blue	RKS-232 denim
						
RKS-173 dark blue	RKS-236 jeans	RKS-170 admiral blue	RKS-199 atlantic blue	RKS-174 navy blue	RKS-175 captain navy	RKS-189 lime





RKS-017 white black



RKS-061 white grey



RKS-056 white brown



RKS-206 cabanes



RKS-252 vanilla beige



RKS-223 perelló



RKS-630 zaidín



RKS-211 falset



RKS-058 ochre brown



RKS-055 white yellow



RKS-012 white red



RKS-016 white blue



RKS-166 foix



RKS-014 white green



RKS-144 maella

Other combinations of colours also available

								
1001	1003	1006	1011	1013	1014	1015	1016	1019
								
1024	1032	1033	1034	2002	2009	2011	3000	3002
								
3003	3005	3007	3012	3013	3017	3022	4001	4003
								
4005	4007	4009	5000	5003	5004	5009	5011	5012
								
5013	5017	5018	5020	5022	5024	6001	6005	6007
								
6009	6011	6013	6016	6017	6019	6025	6026	6027
								
7000	7001	7003	7006	7008	7010	7012	7016	7021
								
7023	7030	7031	7035	7036	7037	7039	7042	7047
								
8001	8007	8014	8016	8019	8022	8023	8024	8025
								
8028	9001	9002	9003	9004	9005	9010	9011	9016

This is a selection of the most popular colours, please note, we are able to match any RAL colour.

Concealed Pipe Trims





			
RKS-099 white	RKS-155 blue marble	RKS-122 seashell	RKS-117 raw
			
RKS-415 marble	RKS-148 desert	RKS-115 cream	RKS-121 wheat
			
RKS-779 beige tweed	RKS-180 sand	RKS-145 tenerife	RKS-133 cinnamon
			
RKS-126 linen	RKS-107 champagne	RKS-108 vanilla	RKS-113 cava
			
RKS-119 duna	RKS-100 beige	RKS-139 heather beige	RKS-143 hemp beige
			
RKS-775 linen tweed	RKS-188 lemon	RKS-554 yellow	RKS-149 corn
			
RKS-111 camel	RKS-158 ochre	RKS-778 mandarin tweed	RKS-101 mandarin
			
RKS-567 orange	RKS-106 flamingo	RKS-105 salmon	RKS-176 red
			
RKS-182 vermillion	RKS-154 pacharán	RKS-777 cherry tweed	RKS-177 burgundy
			
RKS-104 chestnut	RKS-195 cacao	RKS-156 brown	RKS-181 coffee
			
RKS-015 rockwood red	RKS-165 mauve	RKS-110 lilly	RKS-193 light blue

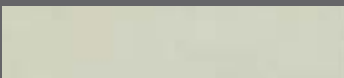
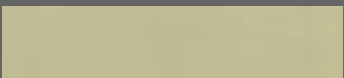
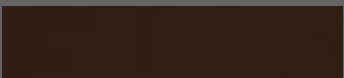

Concealed Pipe Trims

			
RKS-171 turquoise	RKS-169 steel blue	RKS-172 blue	RKS-173 dark blue
			
RKS-170 admiral	RKS-199 atlantic blue	RKS-174 navy blue	RKS-175 captain navy
			
RKS-160 pistachio	RKS-162 khaki	RKS-142 emerald	RKS-163 green
			
RKS-102 forest green	RKS-771 green tweed	RKS-114 pearl	RKS-112 graphite
			
RKS-123 argenta grey	RKS-138 cadet grey	RKS-161 grey	RKS-152 taupe
			
RKS-127 moonrock	RKS-776 taupe tweed	RKS-774 smoke tweed	RKS-164 charcoal grey
			
RKS-151 slate	RKS-770 charcoal tweed	RKS-150 dark grey	RKS-103 black

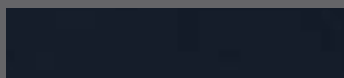
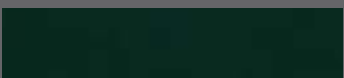
Concealed Tape Trims

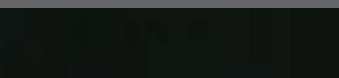
			
oyster	linen	true brown	burgundy
			
navy	forest green	cadet grey	black

Other colours are available subject to requirement

